

DOCUMENTACIÓN TÉCNICA

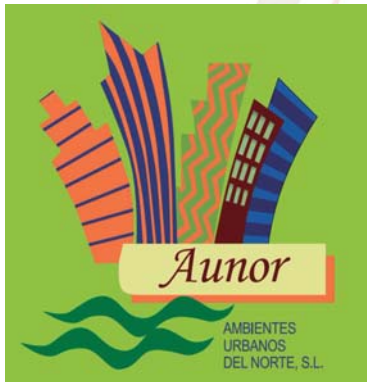

Ref.: TR004

Trepa N°4

UNE EN 1176-1: 2009



marca
acreditada
por



Componentes plásticos: Polietileno de Alta Densidad con protección UV

Altura libre de caída: 1,40m

Trepa de cuerda con alma de acero

Tornillería protegida con tapones de polipropileno

Tubos de acero inoxidable

Madera tratada en autoclave Nivel IV

Alzado

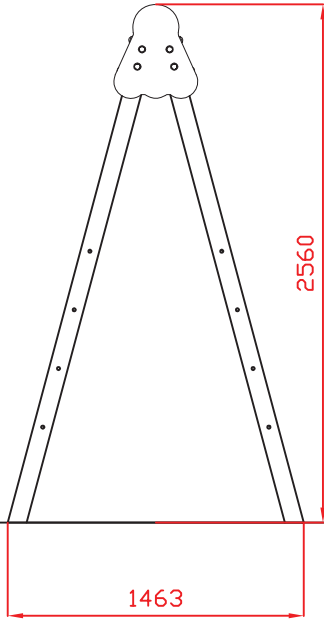

Perfil Izquierdo

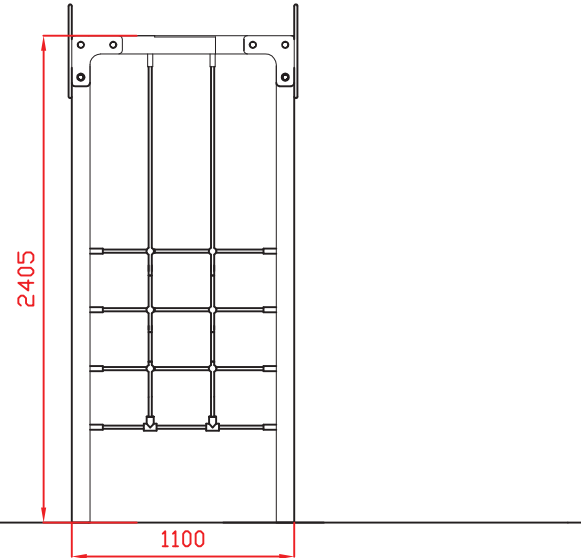

Planta

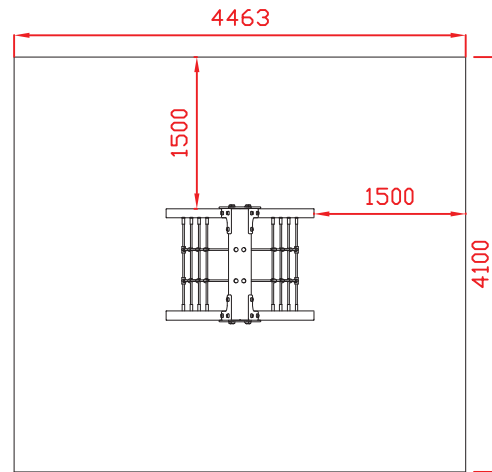
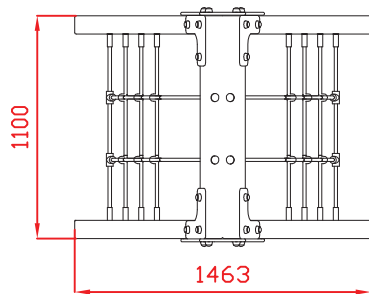

Área de seguridad
Superficie=18,30 m²
E: 1/2



Ref:	Cantidad	Designación	Material	Dimensiones
Dibujado		PLANO 1	Ref.: TR004	
Revisado		VISTAS GENERALES		
Aprobado				
Descripción:		TREPA N°4	Escala:	Peso:
			Fecha:	7-7-15

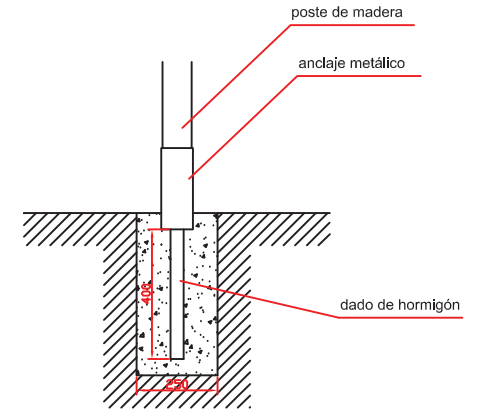
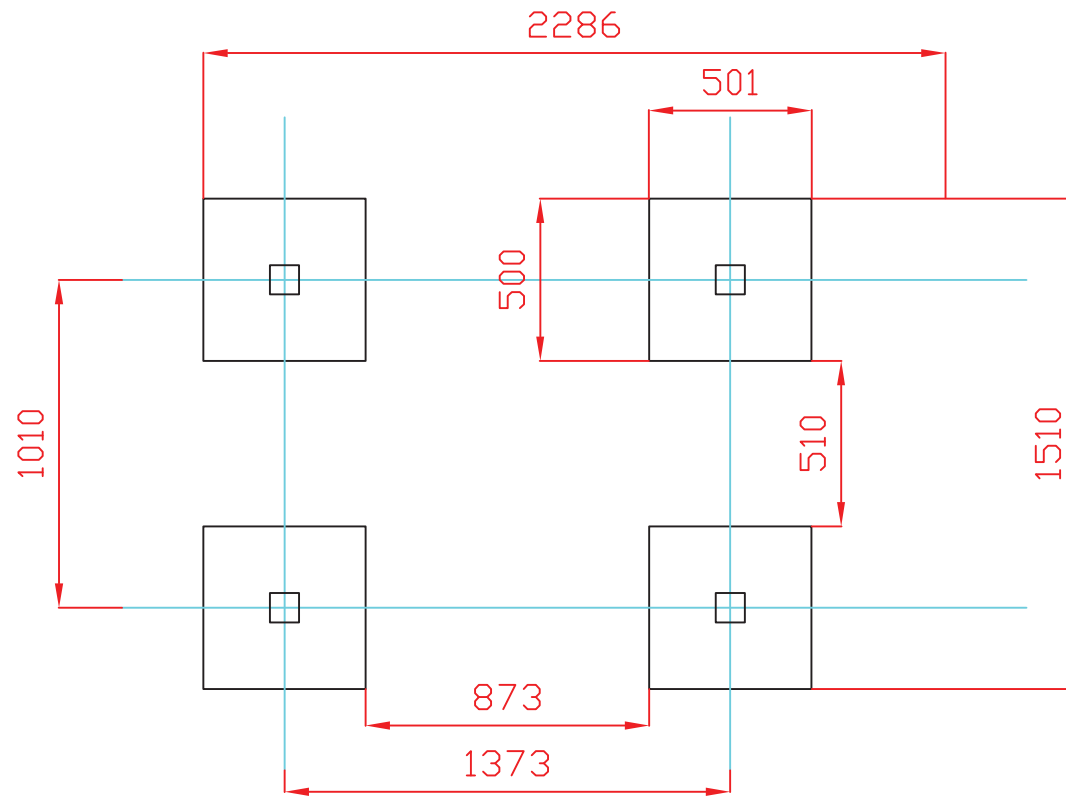

DETALLE DE CIMENTACIÓN

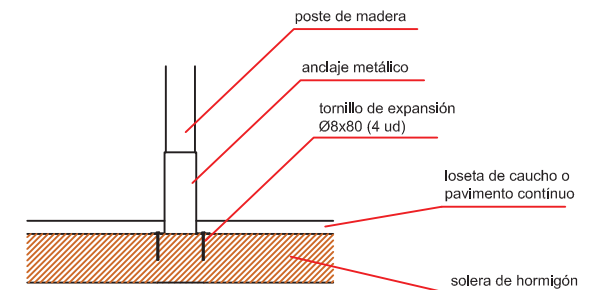

DETALLE DE ANCLAJE



Ref:	Cantidad	Designación	Material	Dimensiones
Dibujado		PLANO 2	Ref.: TR004	
Revisado		CIMENTACIÓN		
Aprobado				
Descripción:		TREPA N°4	Escala:	Peso:
			Fecha:	7-7-15