

DOCUMENTACIÓN TÉCNICA

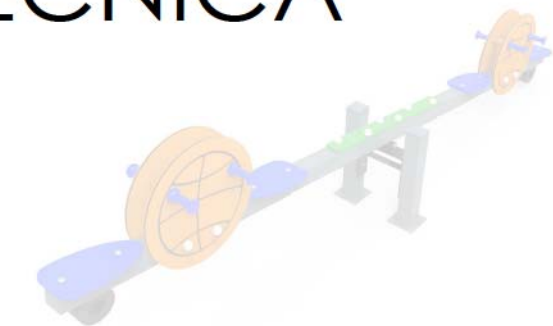

Ref.: BLC06-M

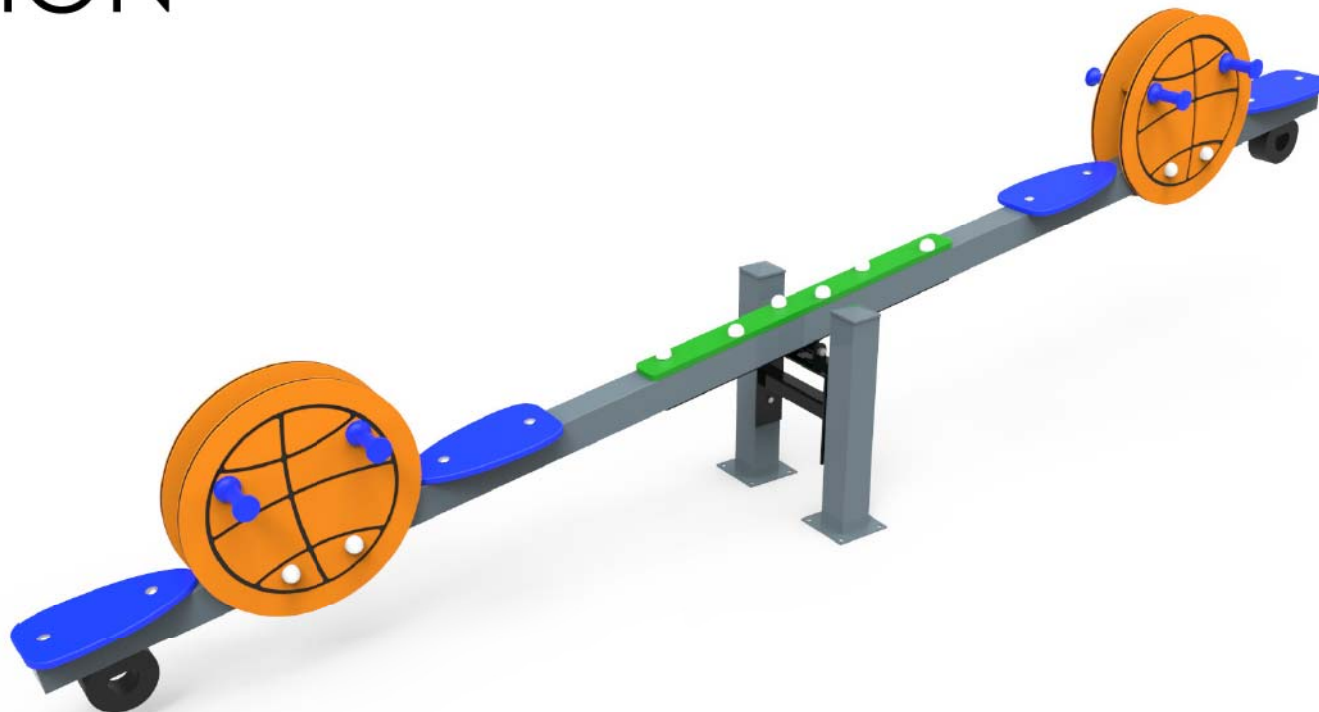

Balancín "Sport 4 plazas metálico"

UNE EN 1176-1:2018

UNE EN 1176-6:2018



Altura libre de caída: 1,00 m
Edad recomendada de uso: de 3 a 9 años
Componentes plásticos: Polietileno de alta densidad con protección UV
Componentes metálicos galvanizados

ALZADO

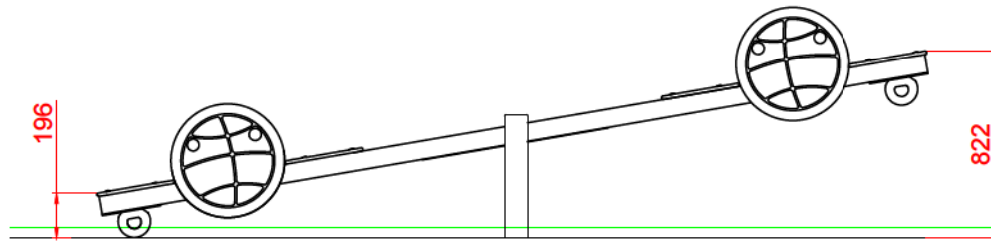

PERFIL

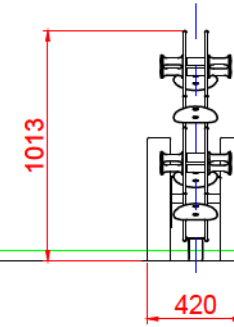

PLANTA

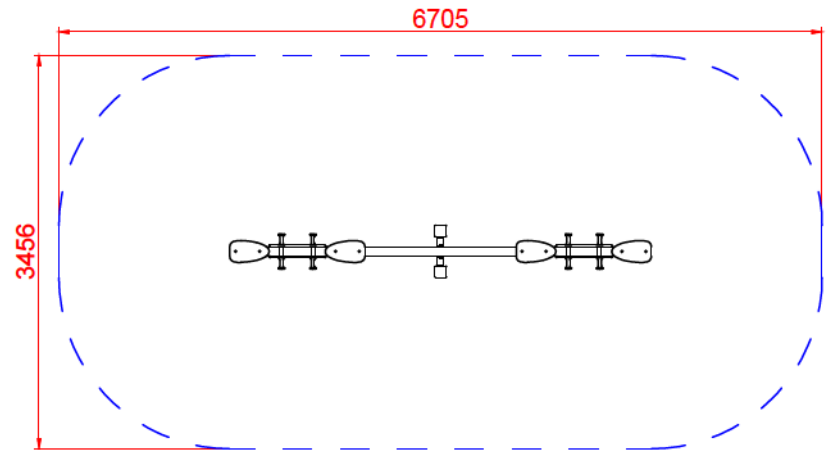
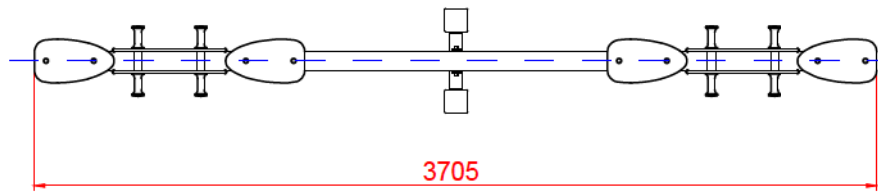

ÁREA DE SEGURIDAD
Superficie= 21 m²
E:1/2

Dibujado		PLANO 1 VISTAS GENERALES	Ref: BLC06-M	
Revisado				
Aprobado				
Descripción: SUBE Y BAJA "SPORT 4 PLAZAS METÁLICO"		Escala:	Nº Hoja 2/4	
		Fecha:	07-05-2019	

DETALLES CIMENTACIÓN

ESQUEMA DE CIMENTACIÓN
EN ARENA

ALZADO

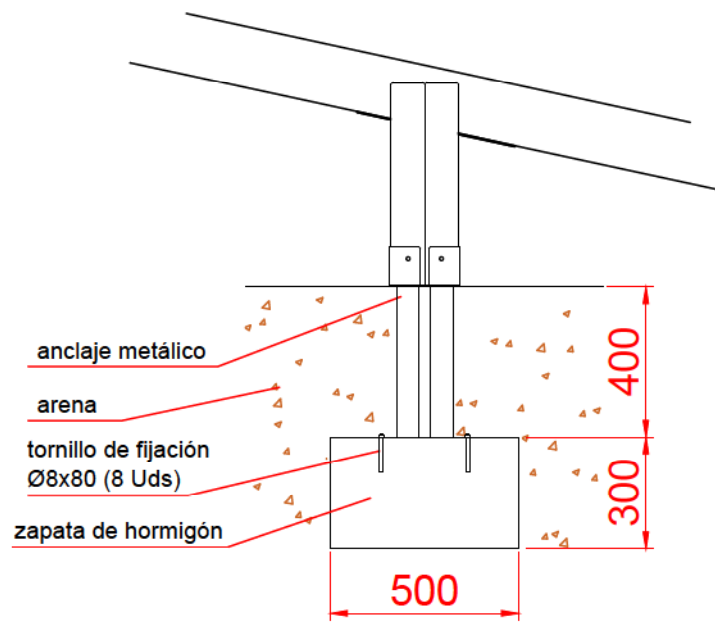

PLANTA

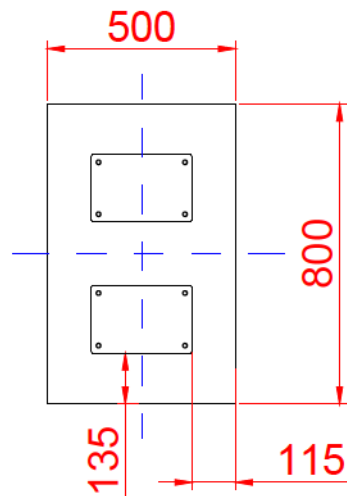

ESQUEMA DE CIMENTACIÓN
EN HORMIGÓN

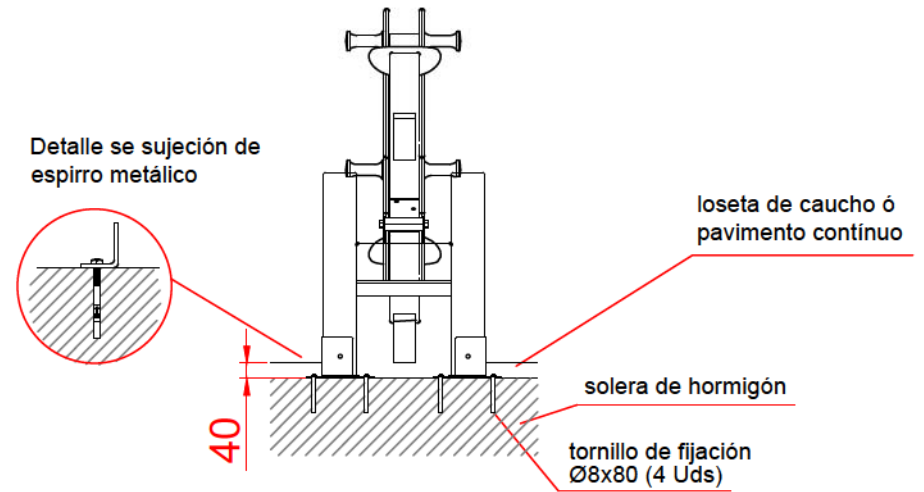

Dibujado		PLANO 2 CIMENTACIÓN Y ANCLAJES	Ref:	BLC06-M
Revisado				
Aprobado				
Descripción:		Escala:	Nº Hoja	
SUBE Y BAJA "SPORT 4 PLAZAS METÁLICO"			3/4	
		Fecha:	07-05-2019	

ALZADO

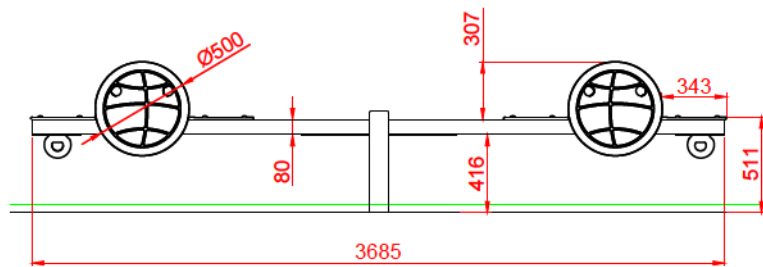

PERFIL

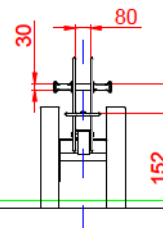

ALZADO POSICIÓN DE APOYO

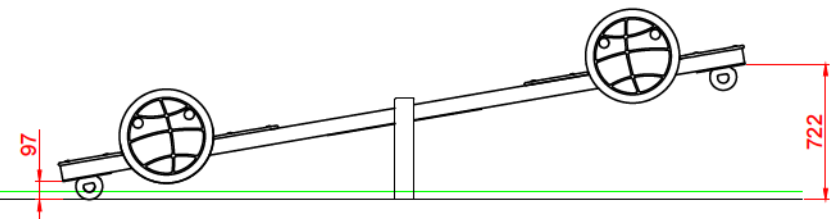

PLANTA

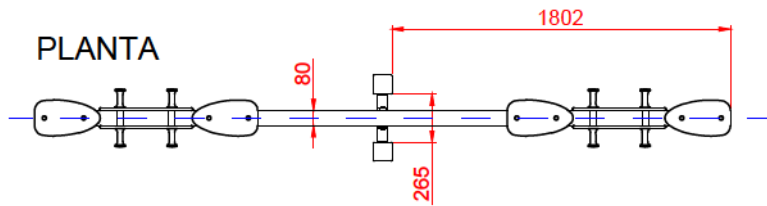

Dibujado		PLANO 3 VISTAS DE DETALLE	Ref:	BLC06-M
Revisado				
Aprobado				
Descripción:		Escala:	Nº Hoja	
SUBE Y BAJA "SPORT 4 PLAZAS METÁLICO"			4/4	
		Fecha:	07-05-2019	